

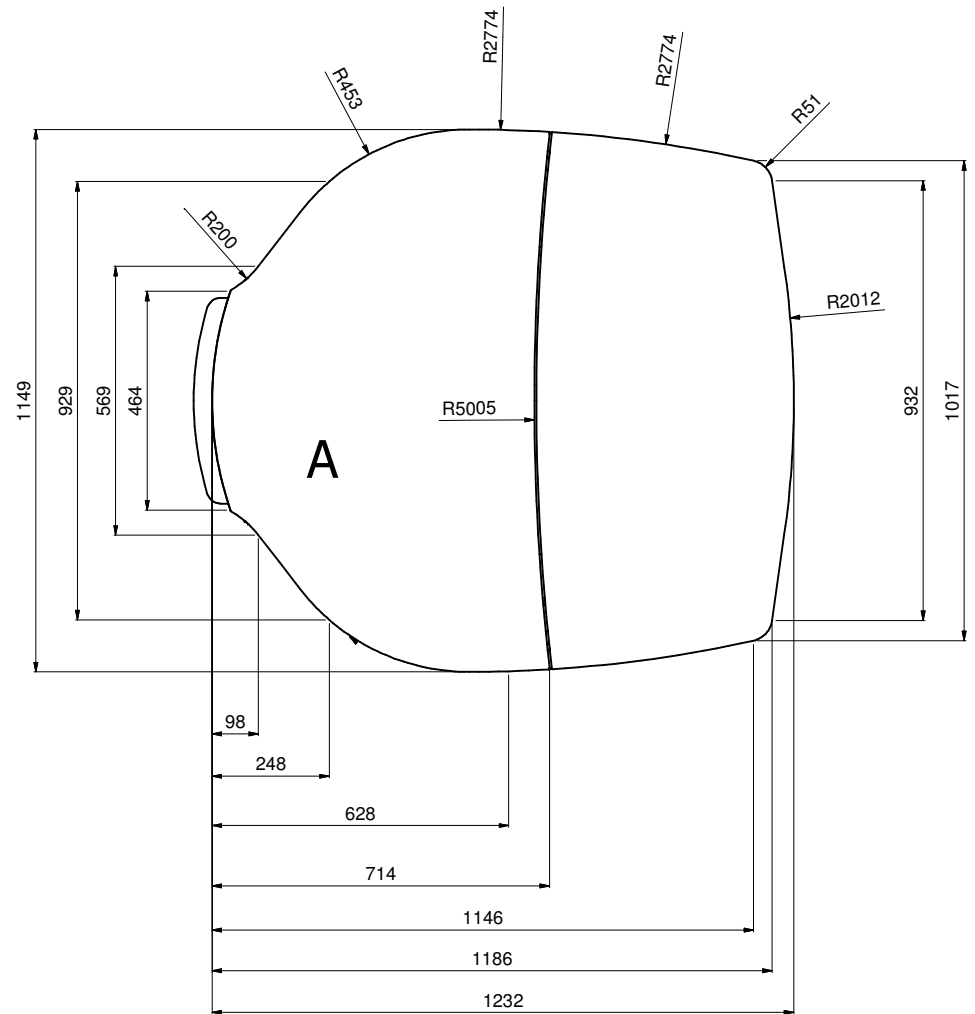

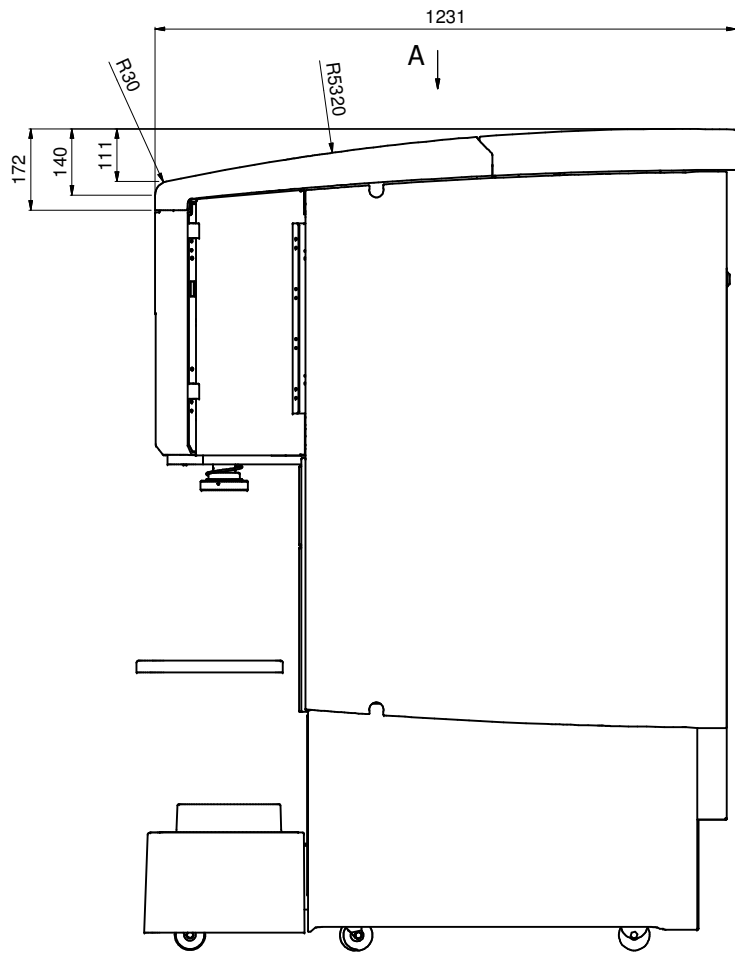



Sticker dimensions

Drawn by		Drawing according to ISO 1101, ISO 406, NEN 3634	ISO 5457
Material	Unit	mm	END PRODUCT SEMI MANUFACTURED
Remark 1	Dims		Project
Remark 2	Colour		
<p>THE NETHERLANDS P.O. Box 2201 2170 AE Sassenheim - Nieuwe Dreefweg 31 2171 K2 Sassenheim - Tel: +31(0)352 240 800 - Fax: +31(0)352 240 880</p> <p>FAST & FLUID</p>		<p>A Unit of</p> <p>ISO 9001</p>	<p>Linear dimension</p> <p>Angular dimension</p>
<p>FAST & FLUID</p> <p>Assembly Part number</p> <p>DESCRIPTION</p>		<p>2000-4000 ± 2 <-10 ±1°</p> <p>1000-2000 ± 1.2 10-50 ± 0°30'</p> <p>400-1000 ± 0.8 5-120 ± 0°20'</p> <p>120-400 ± 0.5 120-400 ± 0°10'</p> <p>30-120 ± 0.3 40-120 ± 0°5'</p> <p>0-30 ± 0.2 0.5-3 ± 0°2'</p> <p>0-6 ± 0.1 3-6 ± 0°5'</p> <p>0-0.3 ± 0.1 0-3 ± 1'</p>	<p>Scale</p> <p>ISO 5457</p> <p>A2</p>
<p>FAST & FLUID</p> <p>NETHERLANDS</p>		<p>HA650 Assy</p>	<p>Drawing Number</p> <p>HA650</p>

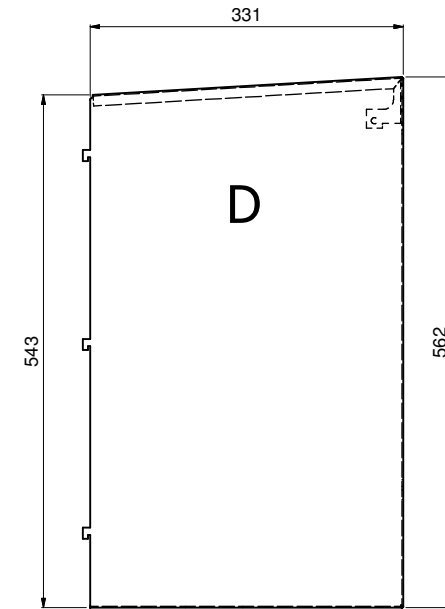
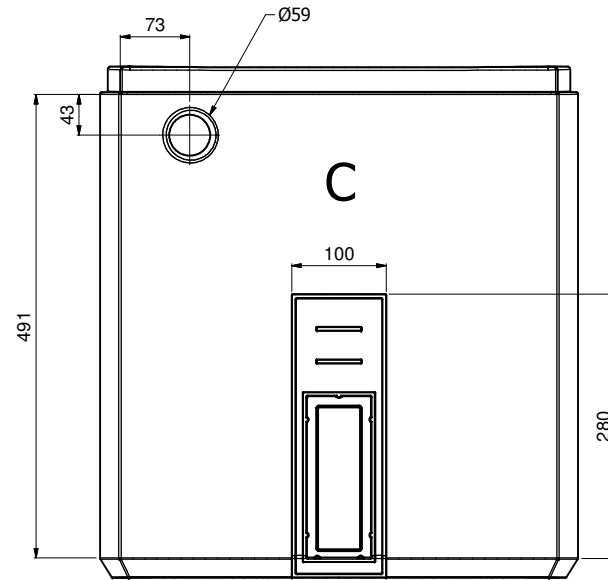
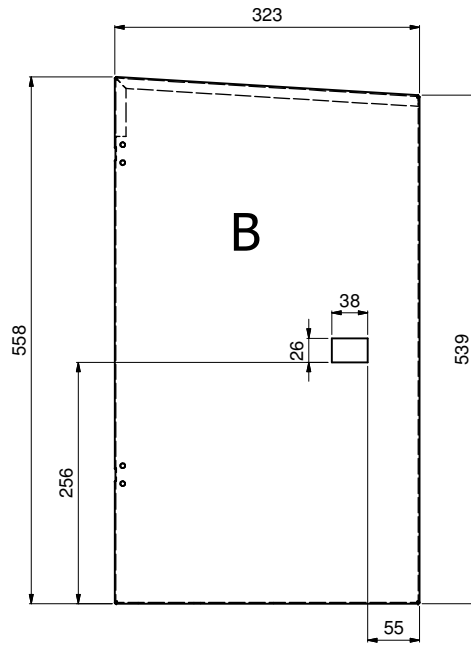
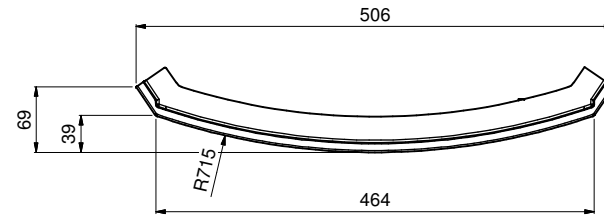



Drawn by		Drawing according to ISO 1101, ISO 406, NEN 3634		ISO-5457
Material		Unit	mm	END PRODUCT SEMI MANUFACTURED
Remark 1		Dims		Project
Remark 2		Colour		
 THE NETHERLANDS P.O. Box 2201 2170 AE Spaarndam • Hub van Doornweg 31 1217 K2 Spaarndam • Tel: +31(0)20 240 800 • Fax: +31(0)20 240 880 ITALY: Via Petrucci da Volpato, 195/111 - 20092 Cinisello Balsamo - Milano • Tel: +39 02 66991.1 • Fax: +39 02 66991.550 CONFIDENTIAL PROPRIETARY MATERIAL: All design, reproduction, manufacturing, use & sales rights of items shown here on or of articles fabricated therefrom are expressly reserved by FAST & FLUID 62/008				Scale
Assembly Part number	Description		HA650 assy	Drawing Number
NETHERLANDS				HA650



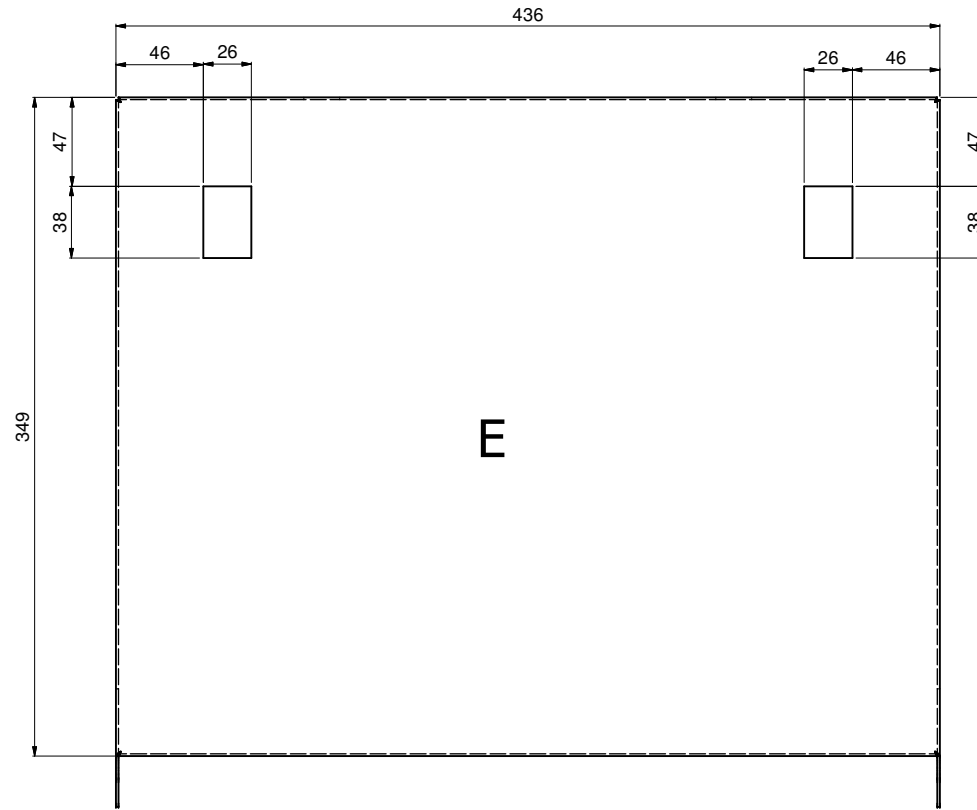

Drawn by	rboon	Drawing according to ISO 1101, ISO 406, NEN 3634		ISO-5457
Material		Unit	mm	END PRODUCT SEMI MANUFACTURED
Remark 1		Dims		Project
Remark 2		Colour		HA450
 THE NETHERLANDS P.O. Box 2201 2170 AE Sassenheim • Hub van Doornweg 31 2171 KZ Sassenheim • Tel: +31(0)252 240 800 • Fax: +31(0)252 240 880 ITALY: Via Petrucci da Volpato, 195/111 - 20092 Cinisello Balsamo - Milan - Tel: +39 0268991.1 - Fax: +39 0268991.550 CONFIDENTIAL PROPRIETARY MATERIAL: All design, reproduction, manufacturing, use & sales rights of items shown here on or of articles fabricated therefrom are expressly reserved by FAST & FLUID 02/2008				Scale
 THE NETHERLANDS		Assembly Part number	Description	Drawing Number
			panel,front,HA450	1813726



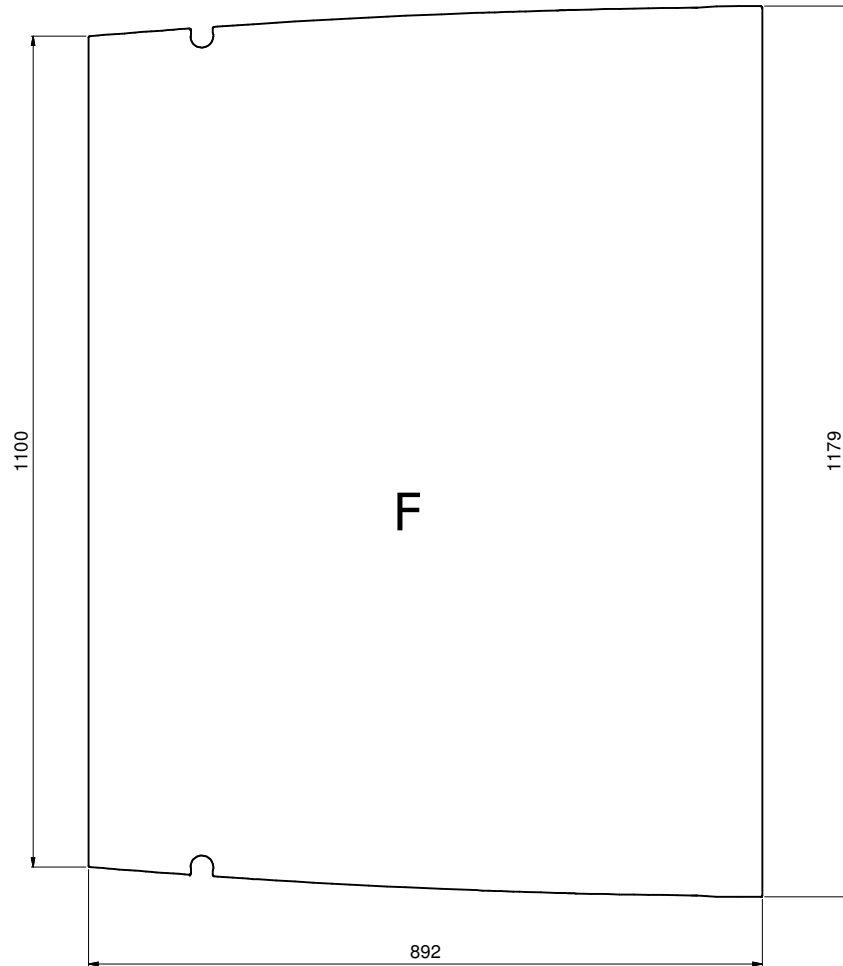
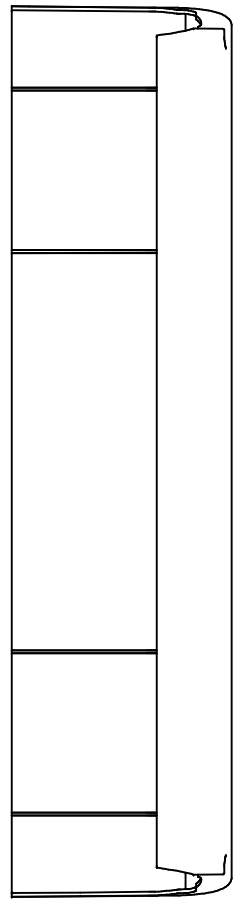
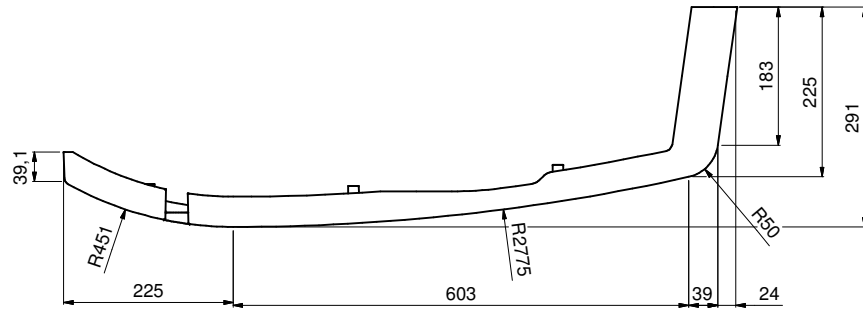

Drawn by	rboon	Drawing according to ISO 1101, ISO 406, NEN 3634		ISO-5457
Material		Unit	mm	END PRODUCT SEMI MANUFACTURED
Remark 1		Dims		Project
Remark 2		Colour		HA450
		<small>THE NETHERLANDS P.O. Box 2201 2170 AE Sassenheim - Hub van Doornweg 31 2171 K2 Sassenheim - Tel: +31(0)352 240 800 - Fax: +31(0)352 240 880</small> <small>FAST & FLUID</small>		
<small>FAST & FLUID</small> <small>THE NETHERLANDS</small>		<small>CONFIDENTIAL PROPRIETARY MATERIAL. All design, reproduction, manufacturing, use & sales rights of items shown here on or of articles fabricated therefrom are expressly reserved by FAST & FLUID 62208</small>	<small>Project</small> HA450	
<small>Assembly Part number</small>		<small>Description</small> panel,front,bot.HA450		<small>Drawing Number</small> 1813739



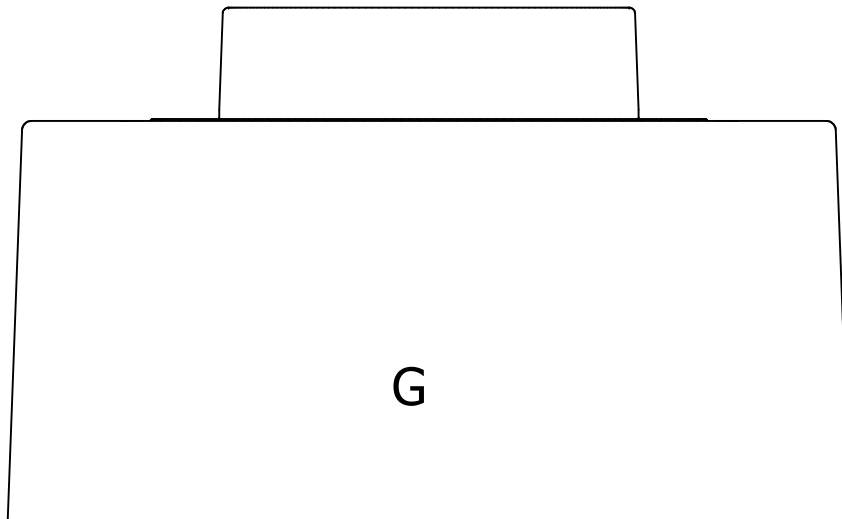
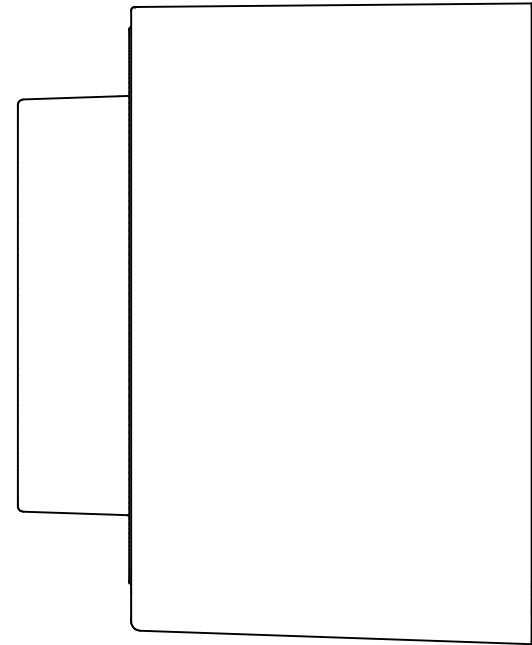
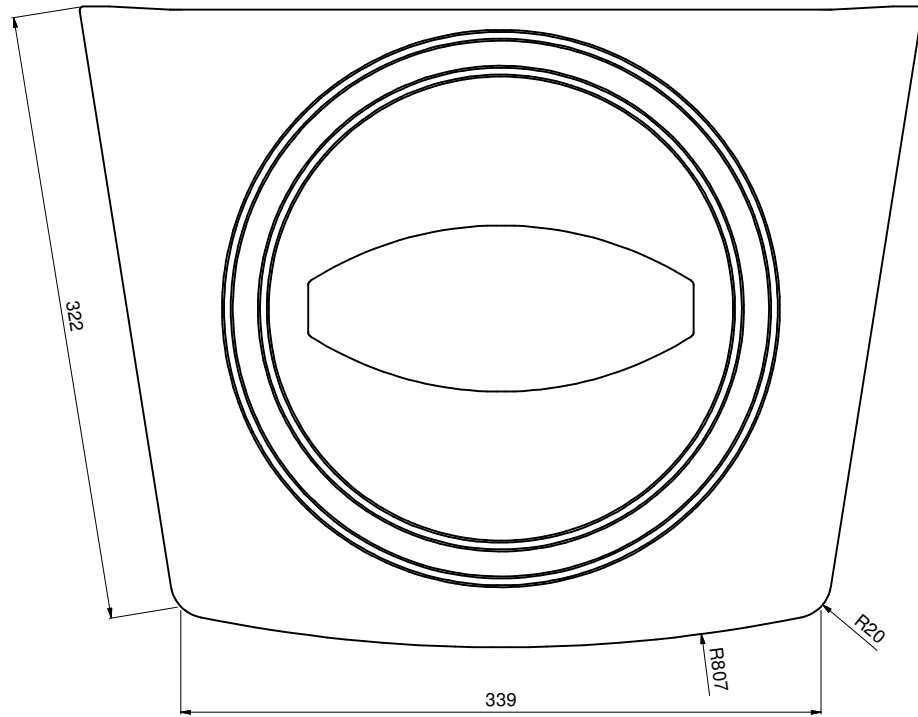

Drawn by	BPeeters	Drawing according to ISO 1101, ISO 406, NEN 3634		ISO-5457
Material		Unit	mm	END PRODUCT SEMI MANUFACTURED
Remark 1		Dims		Project
Remark 2		Colour		HA650
		<small>THE NETHERLANDS P.O. Box 2201 3170 AE Sassenheim • Hub van Doornweg 31 2171 KZ Spaarndam • Tel. +31(0)20 240 800 • Fax +31(0)20 240 880</small> <small>ITALY Via Pirella da Volpato, 195/111 - 20092 Cinisello Balsamo - Milan • Tel. +39 02 66991.1 • Fax +39 02 66991.550</small> <small>CONFIDENTIAL PROPRIETARY MATERIAL. All design, reproduction, manufacturing, use & sales rights of items shown here on or of articles fabricated therefrom are expressly reserved by FAST & FLUID 612/08</small>		
<small>THE NETHERLANDS</small> <small>NETHERLANDS</small>		<small>Assembly Part number</small> <small>Description</small>	<small>Drawing Number</small> 1814593	
			Panel,side,top,HA650	



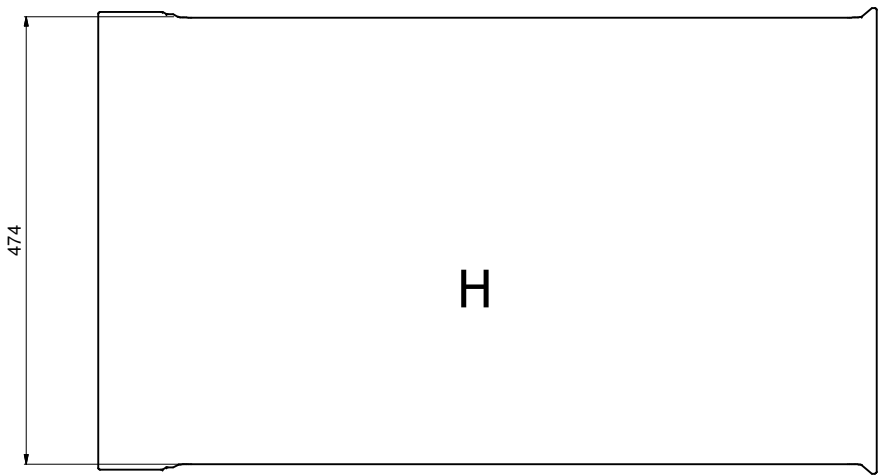
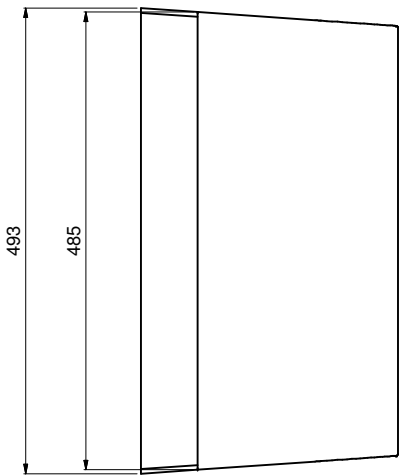
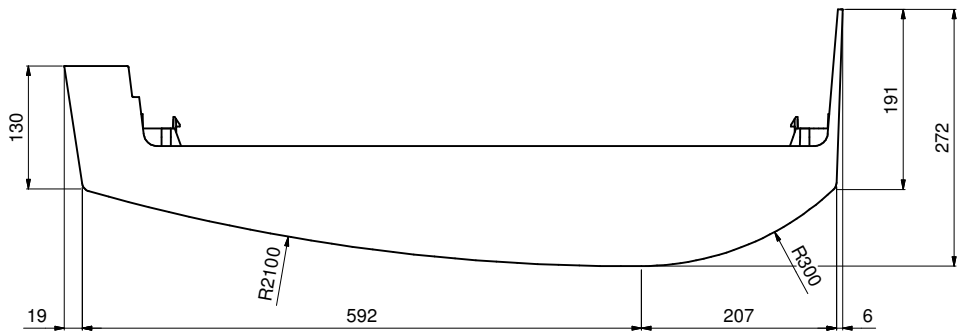

Drawn by	MEngels	Drawing according to ISO 1101, ISO 406, NEN 3634		ISO-5457
Material		Unit	mm	END PRODUCT SEMI MANUFACTURED
Remark 1		Dims		Project
Remark 2		Colour		HA450
		<small>THE NETHERLANDS P.O. Box 2201 2170 AE Sassenheim • Hub van Doornweg 31 2171 KZ Spaarndam • Tel: +31(0)20 240 800 • Fax: +31(0)20 240 880</small> <small>FAST & FLUID</small>		
<small>FAST & FLUID</small> <small>THE NETHERLANDS</small>		<small>CONFIDENTIAL PROPRIETARY MATERIAL. All design, reproduction, manufacturing, use & sales rights of items shown here on or of articles fabricated therefrom are expressly reserved by FAST & FLUID 02/2008</small>	<small>Assembly Part number</small>	<small>Description</small>
			cover,cantable,HA450	<small>Drawing Number</small> 1864107
				A2
				Scale

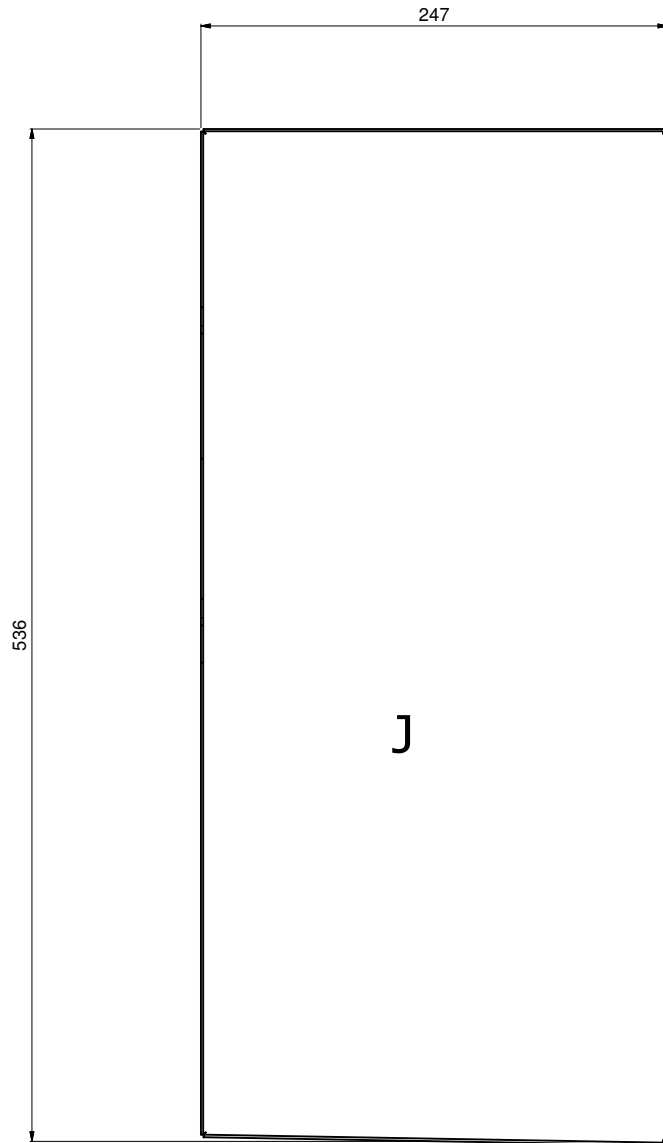

Drawn by	ME	Drawing according to ISO 1101, ISO 406, NEN 3634		ISO-5457
Material		Unit	mm	END PRODUCT SEMI MANUFACTURED
Remark 1		Dims		Project
Remark 2		Colour		HA650
		<small>THE NETHERLANDS P.O. Box 2201 3170 AE Sassenheim - h.van Doornweg 31 2171 K2 Sassenheim - Tel: +31(0)252 240 800 - Fax: +31(0)252 240 880</small> <small>ITALY: Via Pirella da Volpato, 195/111 - 20092 Cinisello Balsamo - Milano - Tel: +39 0268991.1 - Fax: +39 0268991.550</small> <small>CONFIDENTIAL PROPRIETARY MATERIAL. All design, reproduction, manufacturing, use & sales rights of items shown here on or of articles fabricated therefrom are expressly reserved by FAST & FLUID 02/2008</small>		
<small>FAST & FLUID</small> <small>THE NETHERLANDS</small>		<small>Assembly Part number</small>	<small>Description</small>	<small>Drawing Number</small> 1814594
			panel.bot.RL,HA650	A2 Scale



Drawn by	rboon	Drawing according to ISO 1101, ISO 406, NEN 3634		ISO-5457	
Material		Unit	mm	END PRODUCT SEMI MANUFACTURED	
Remark 1		Dims		Project	
Remark 2		Colour		HA650	
		<small>THE NETHERLANDS P.O. Box 2201 2170 AE Sassenheim • Hub van Doornweg 31 2171 KZ Sassenheim • Tel. +31(0)252 240 800 • Fax +31(0)252 240 880</small> <small>ITALY Via Piavezza da Volpato, 195/111 - 20092 Cinisello Balsamo - Milan • Tel. +39 0266991.1 • Fax +39 0266991.550</small> <small>CONFIDENTIAL PROPRIETARY MATERIAL. All design, reproduction, manufacturing, use & sales rights of items shown here on or of articles fabricated therefrom are expressly reserved by FAST & FLUID 02/2008</small>			A2 Scale
<small>THE NETHERLANDS</small>		Assembly Part number	Description	Drawing Number	
		Side,panel,R,HA650		1815152	