









Drawn by	Drawing according to ISO 1101, ISO 406, NEN 3634		All dim's acc. to ISO 2768-M unless otherwise specified	ISO-5457																		
Material	Unit	mm	END PRODUCT SEMI MANUFACTURED	A3																		
Remark 1	Dims		Project																			
Remark 2	Colour			Scale																		
 THE TINTING COMPANY NETHERLANDS			THE NETHERLANDS: P.O. Box 220 2170 AE Sassenheim - Hub van Doorneweg 31 2171 KZ Sassenheim - Tel. +31(0)252 240 800 - Fax +31(0)252 240 880 ITALY: Via Pezzè de Volpedo, 100/111 - 20092 Cinisello Balsamo - Milan - Tel. +39 03620991.1 - Fax +39 0290991.590 CONFIDENTIAL PROPRIETARY MATERIAL: All design, reproduction, manufacturing, use & sales rights of items shown here on or of articles fabricated therefrom are expressly reserved by FAST & FLUID ©2008	A Unit of:  IDEX CORPORATION 																		
			<table border="1"> <tr> <th>Linear dimensions</th> <th>Angular dimensions</th> </tr> <tr> <td>2000-4000 ± 2</td> <td><10 ±1°</td> </tr> <tr> <td>1000-2000 ± 1.2</td> <td>10-50 ± 0°30'</td> </tr> <tr> <td>400-1000 ± 0.8</td> <td>50-120 ± 0°20'</td> </tr> <tr> <td>120-400 ± 0.5</td> <td>120-400 ± 0°10'</td> </tr> <tr> <td>30-120 ± 0.3</td> <td>400-> ± 0°5'</td> </tr> <tr> <td>6-30 ± 0.2</td> <td>0.5-3 ± 0.2</td> </tr> <tr> <td>3-6 ± 0.1</td> <td>3-6 ± 0.5</td> </tr> <tr> <td>0.5-3 ± 0.1</td> <td>6-> ± 1</td> </tr> </table>	Linear dimensions	Angular dimensions	2000-4000 ± 2	<10 ±1°	1000-2000 ± 1.2	10-50 ± 0°30'	400-1000 ± 0.8	50-120 ± 0°20'	120-400 ± 0.5	120-400 ± 0°10'	30-120 ± 0.3	400-> ± 0°5'	6-30 ± 0.2	0.5-3 ± 0.2	3-6 ± 0.1	3-6 ± 0.5	0.5-3 ± 0.1	6-> ± 1	Drawing Number HA450
Linear dimensions	Angular dimensions																					
2000-4000 ± 2	<10 ±1°																					
1000-2000 ± 1.2	10-50 ± 0°30'																					
400-1000 ± 0.8	50-120 ± 0°20'																					
120-400 ± 0.5	120-400 ± 0°10'																					
30-120 ± 0.3	400-> ± 0°5'																					
6-30 ± 0.2	0.5-3 ± 0.2																					
3-6 ± 0.1	3-6 ± 0.5																					
0.5-3 ± 0.1	6-> ± 1																					
Assembly Part number Description Sticker dimensions																						

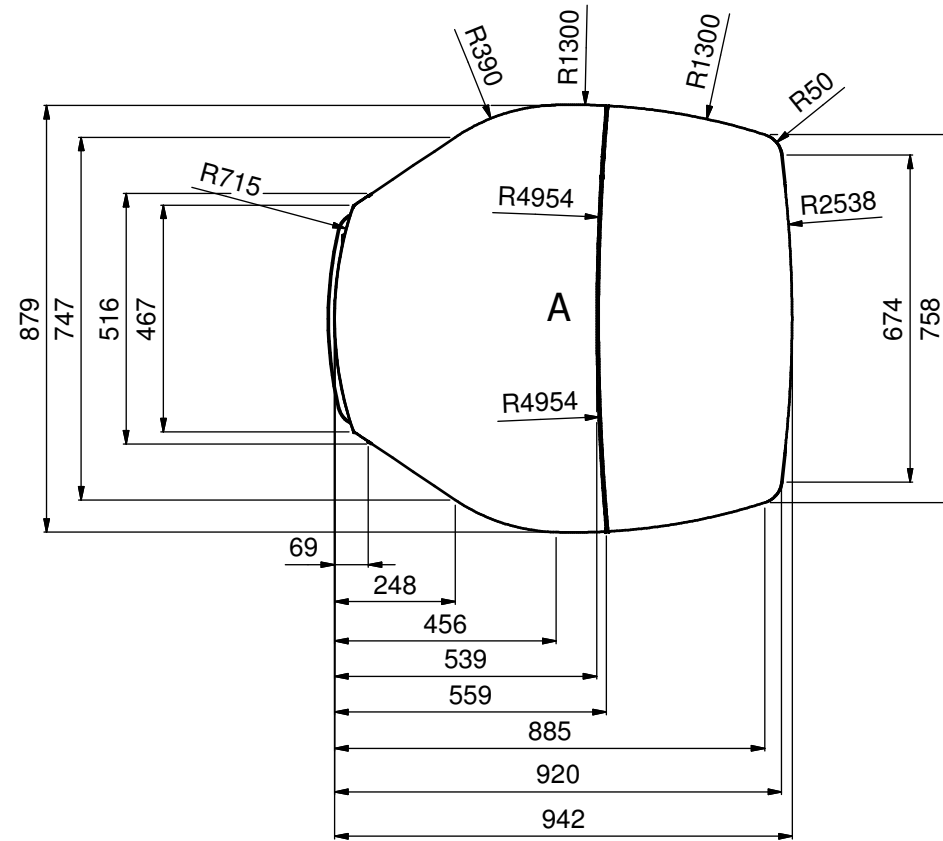
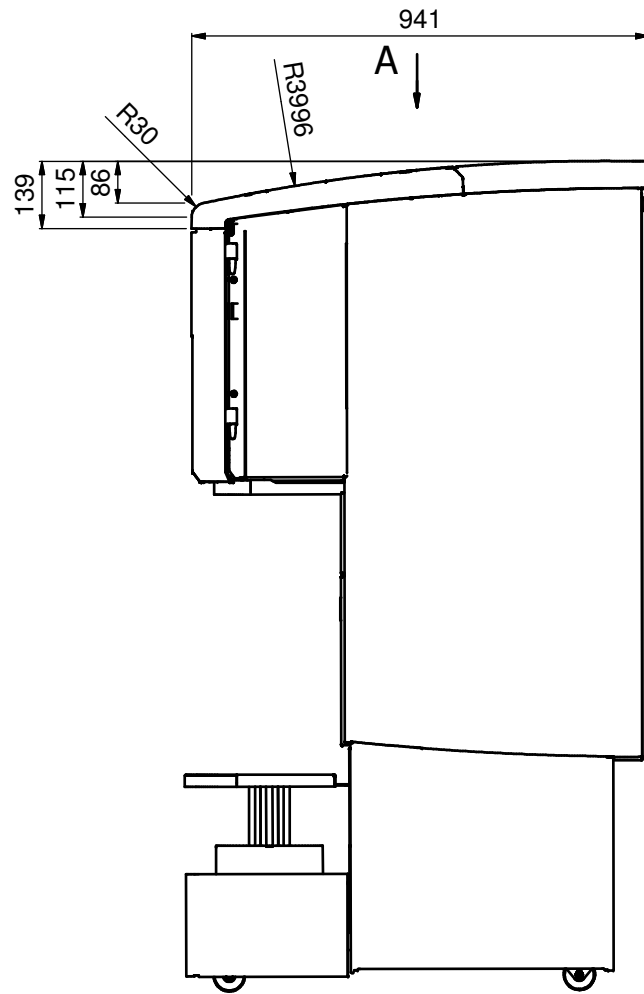

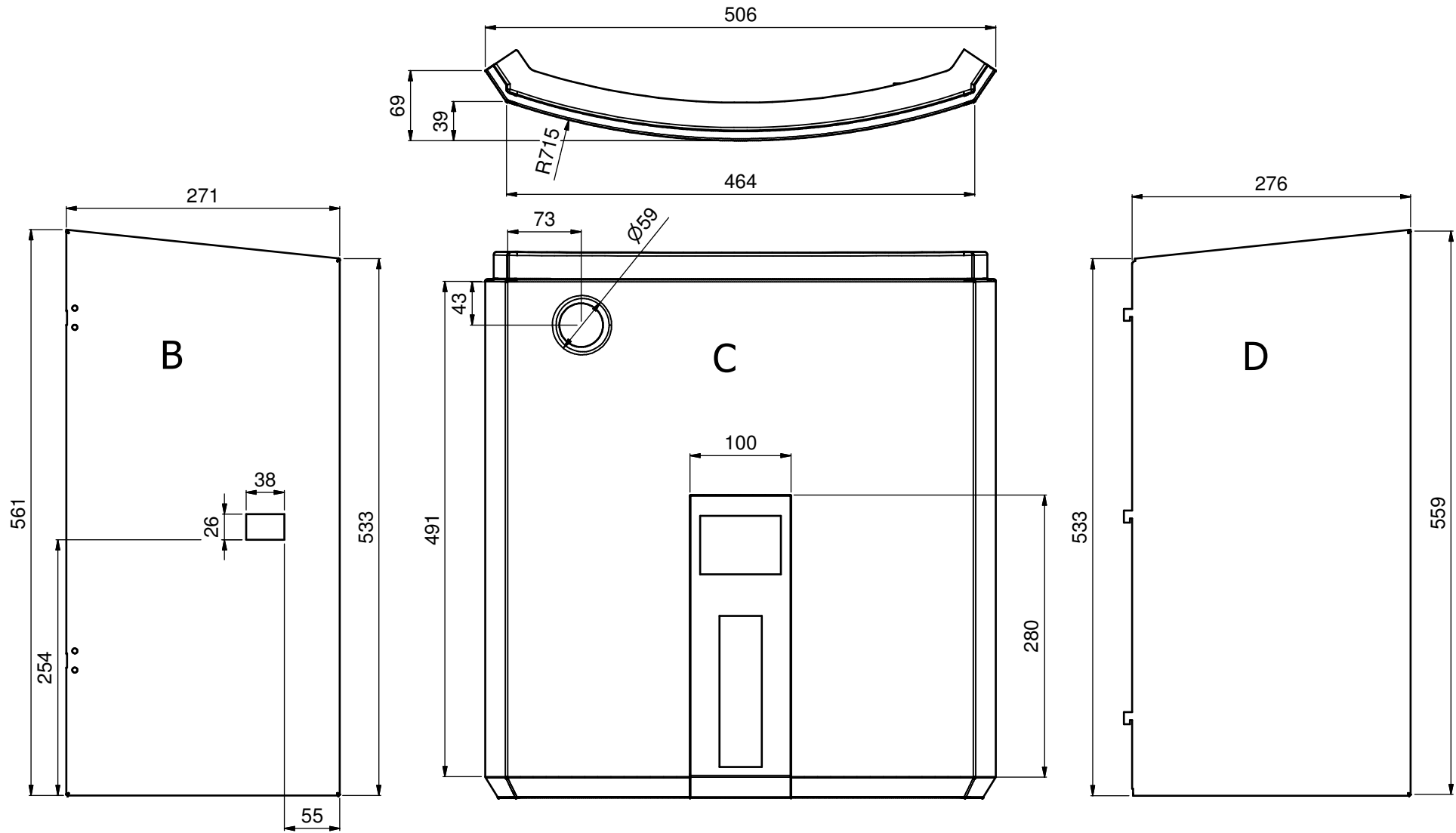

Drawn by	Drawing according to ISO 1101, ISO 406, NEN 3634			ISO-5457	
Material	Unit	mm	END PRODUCT	SEMI MANUFACTURED	
Remark 1	Dims	Project		A3	
Remark 2	Colour				
		<small>THE NETHERLANDS: P.O. Box 220 2170 AE Sassenheim - Hub van Doornweg 31 2171 KZ Sassenheim - Tel. +31(0)252 240 800 - Fax +31(0)252 240 880 ITALY: Via Pezzè de Valpeda, 100/111 - 20092 Cinisello Balsamo - Milan - Tel. +39 036209111 - Fax +39 0293901550</small>			Scale
<small>CONFIDENTIAL PROPRIETARY MATERIAL: All design, reproduction, manufacturing, use & sales rights of items shown here on or of articles fabricated therefrom are expressly reserved by FAST & FLUID ©2008</small>		<small>A Unit of:</small> 	Drawing Number		
<small>FAST & FLUID</small> <small>THE TINTING COMPANY</small> <small>NETHERLANDS</small>		Assembly Part number	Description	Sticker dimensions	HA450



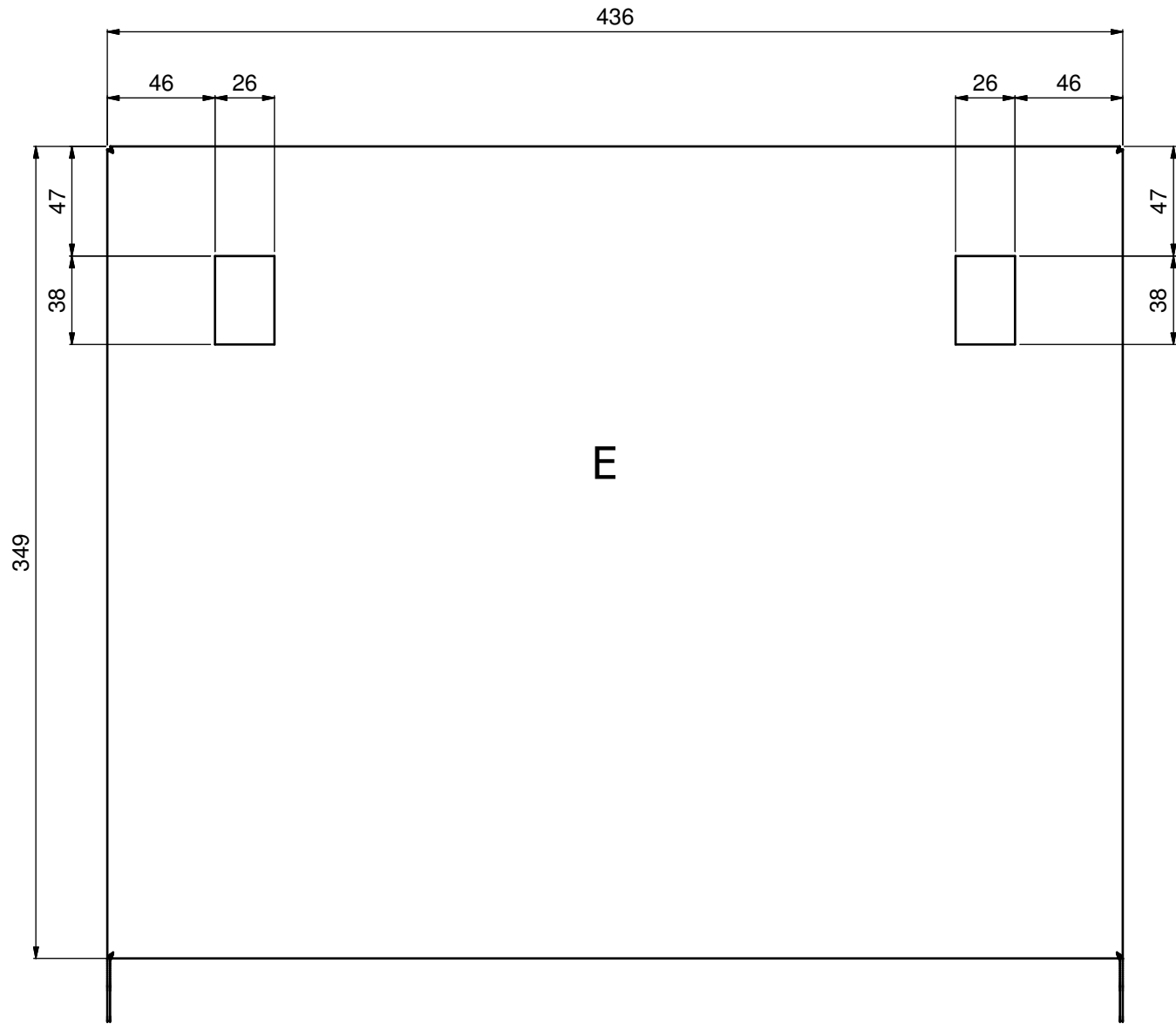

Drawn by	rboon	Drawing according to ISO 1101, ISO 406, NEN 3634		ISO-5457	
Material		Unit	mm		END PRODUCT SEMI MANUFACTURED
Remark 1		Dims		Project	
Remark 2		Colour			HA450
		<small>THE NETHERLANDS: P.O. Box 220 2170 AE Sassenheim - Hub van Doorneweg 31 2171 KZ Sassenheim - Tel. +31(0)252 240 800 - Fax +31(0)252 240 880 ITALY: Via Pezzè de Volpeda, 109/111 - 20092 Cinisello Balsamo - Milan - Tel. +39 0362091.1 - Fax +39 029091.550</small>			
<small>FAST & FLUID THE TINTING COMPANY NETHERLANDS</small>		<small>CONFIDENTIAL PROPRIETARY MATERIAL. All design, reproduction, manufacturing, use & sales rights of items shown here on or of articles fabricated therefrom are expressly reserved by FAST & FLUID ©2008</small>	<small>A Unit of: IDEX CORPORATION</small>	Drawing Number HA450	
Sticker dimensions				A3	



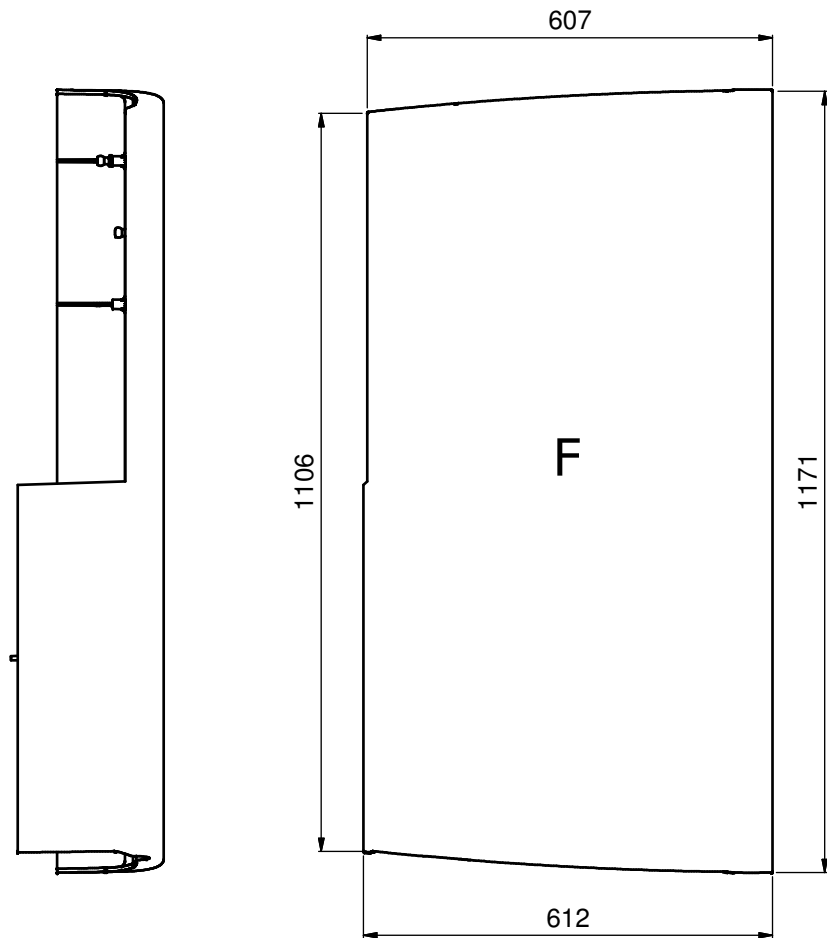
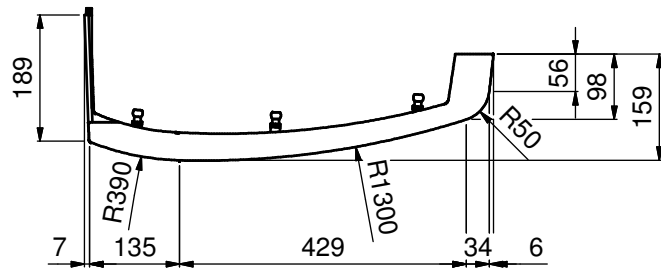

Drawn by	rboon	Drawing according to ISO 1101, ISO 406, NEN 3634		ISO-5457 A3 Scale
Material		Unit	mm	
Remark 1		END PRODUCT	SEMI MANUFACTURED	
Remark 2		Project	HA450	
		<small>THE NETHERLANDS: P.O. Box 220 2170 AE Sassenheim - Hub van Doorneweg 31 2171 KZ Sassenheim - Tel. +31(0)252 240 800 - Fax +31(0)252 240 880 ITALY: Via Pezzè de Volpeda, 100/111 - 20092 Cinisello Balsamo - Milan - Tel. +39 03620991.11 - Fax +39 0290901.550 CONFIDENTIAL PROPRIETARY MATERIAL: All design, reproduction, manufacturing, use & sales rights of items shown here on or of articles fabricated therefrom are expressly reserved by FAST & FLUID ©2008</small>		<small>A Unit of:</small> 
<small>THE TINTING COMPANY NETHERLANDS</small>	<small>Assembly Part number</small>	<small>Description</small> Sticker dimensions	<small>Drawing Number</small> HA450	

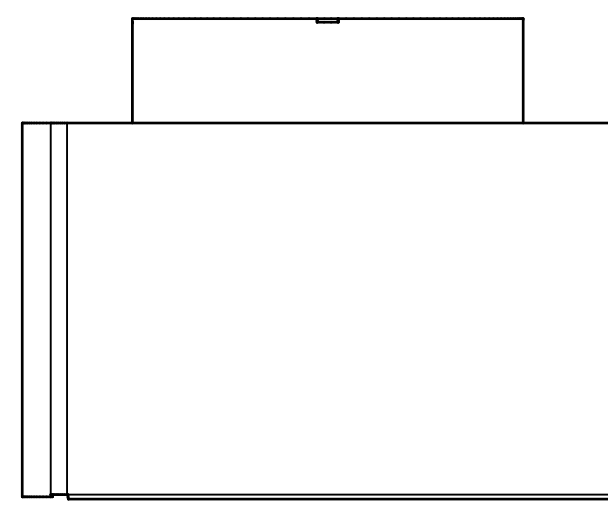
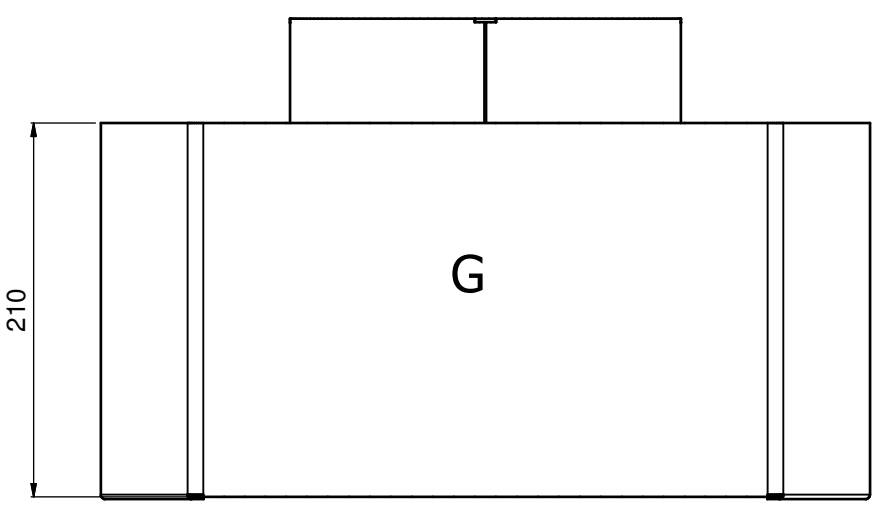
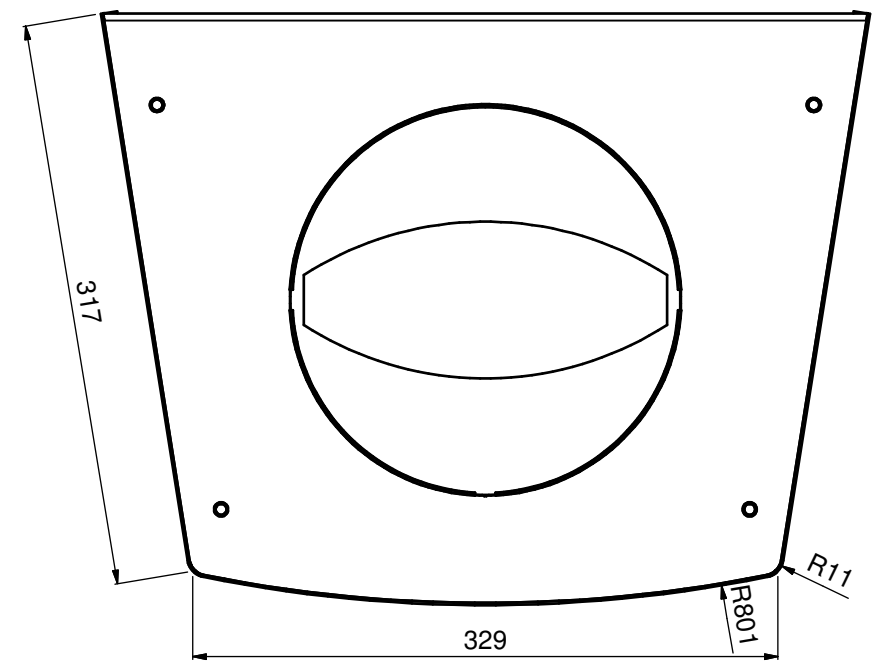

Drawn by	rboon	Drawing according to ISO 1101, ISO 406, NEN 3634		ISO-5457	
Material		Unit	mm	END PRODUCT SEMI MANUFACTURED	
Remark 1		Dims			
Remark 2		Colour		Project	
				HA450	
		<small>THE NETHERLANDS: P.O. Box 220 2170 AE Sassenheim - Hub van Doorneweg 31 2171 KZ Sassenheim - Tel. +31(0)252 240 800 - Fax +31(0)252 240 880 ITALY: Via Pezzè de Volpeda, 100/111 - 20192 Cinisello Balsamo - Milan - Tel. +39 03660991.11 - Fax +39 0290991.550</small>			Scale
<small>THE TINTING COMPANY NETHERLANDS</small>		Assembly Part number	Description	Drawing Number	
			Sticker dimensions	HA450	



Rev.	Description	Revision by	Revision date
------	-------------	-------------	---------------

Drawn by	Drawing according to ISO 1101, ISO 406, NEN 3634			ISO-5457	
Material	Unit	mm	END PRODUCT SEMI MANUFACTURED		
Remark 1	Dims	Project		A3	
Remark 2	Colour	HA450			
 THE TINTING COMPANY NETHERLANDS		THE NETHERLANDS: P.O. Box 220 2170 AE Sassenheim - Hub van Doorneweg 31 2171 KZ Sassenheim - Tel. +31(0)252 240 800 - Fax +31(0)252 240 880 ITALY: Via Pezzè de Volpeda, 100/111 - 20192 Cinisello Balsamo - Milan - Tel. +39 03660991.1 - Fax +39 0290991.550 <small>CONFIDENTIAL PROPRIETARY MATERIAL: All design, reproduction, manufacturing, use & sales rights of items shown here on or of articles fabricated therefrom are expressly reserved by FAST & FLUID ©2008</small>		A Unit of:  	Scale
		Assembly Part number	Description	Drawing Number	
		Sticker dimensions		HA450	



Rev.

Description

Revision by

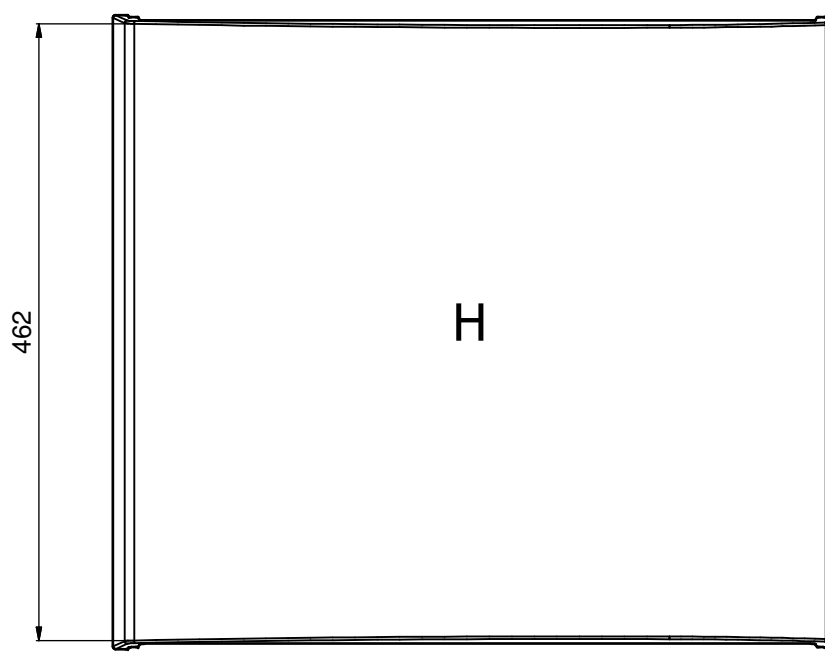
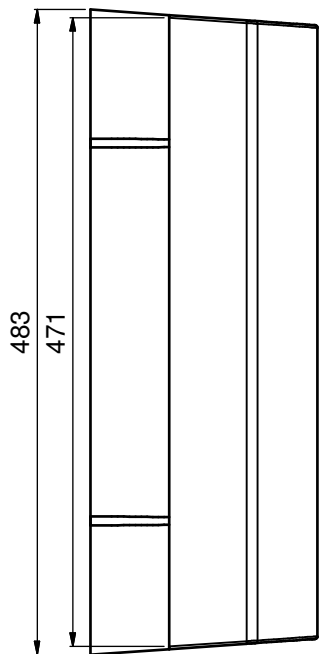
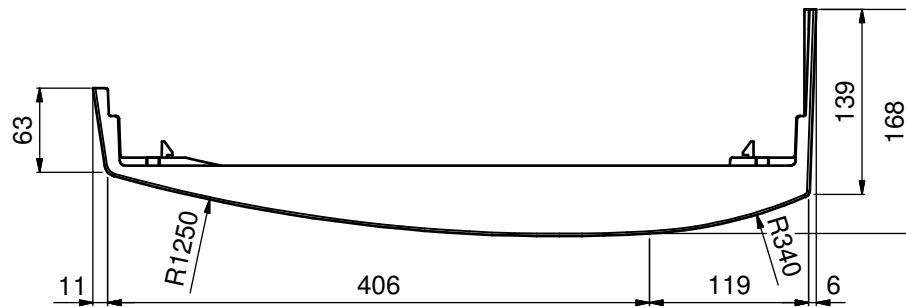
Revision date



Drawn by	Drawing according to ISO 1101, ISO 406, NEN 3634			ISO-5457
Material	Unit	mm	END PRODUCT	SEMI MANUFACTURED
Remark 1	Dims		Project	A3
Remark 2	Colour			Scale
 THE TINTING COMPANY NETHERLANDS		THE NETHERLANDS • P.O. Box 220 2170 AE Sassenheim • Hub van Doorneweg 31 2171 KZ Sassenheim • Tel. +31(0)252 240 800 • Fax +31(0)252 240 880 ITALY: Via Pezzè de Volpeda, 109/111 • 20092 Cinisello Balsamo • Milan • Tel. +39 036209111 • Fax +39 029091150 CONFIDENTIAL PROPRIETARY MATERIAL: All design, reproduction, manufacturing, use & sales rights of items shown here on or of articles fabricated therefrom are expressly reserved by FAST & FLUID ©2008		 A Unit of:  IDEX CORPORATION
Assembly Part number		Description Sticker dimensions		Drawing Number HA450